

abrahams-1

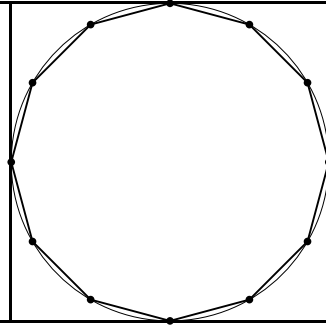

abrahams-2

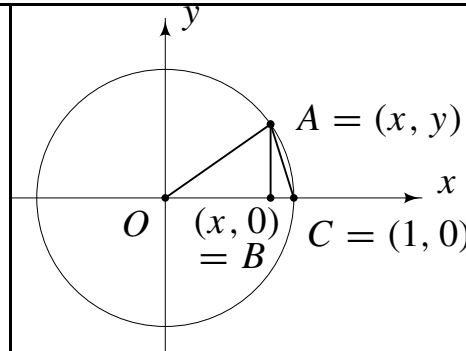

abrahams-3

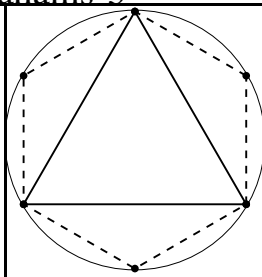

$m = 3 (m = 6)$

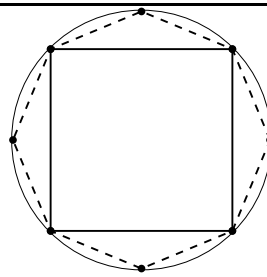

$m = 4 (m = 8)$

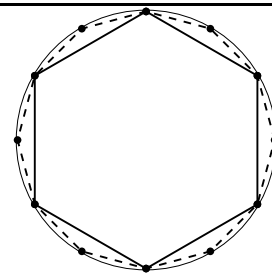

$m = 6 (m = 12)$

abrahams-4

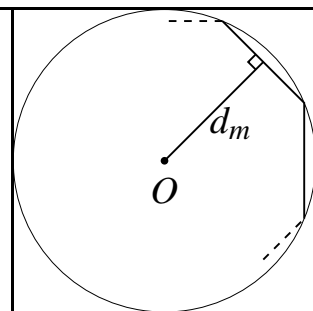

arkeryd1-1

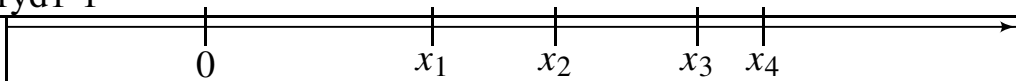

arkeryd1-2

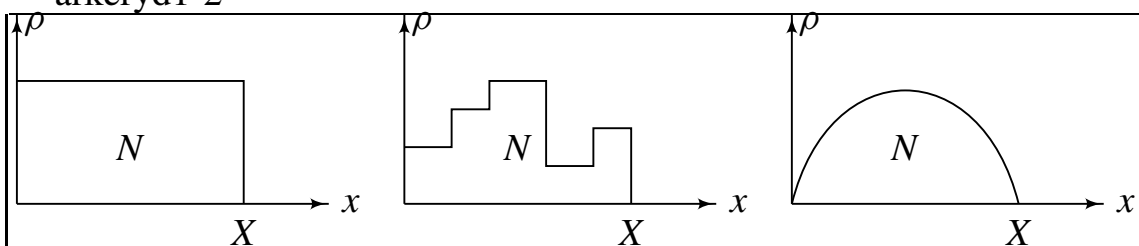

arkeryd1-3

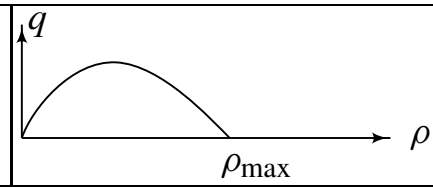

arkeryd1-4

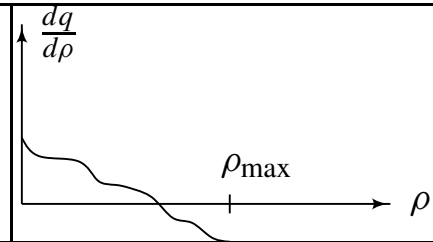

bjoerner-01

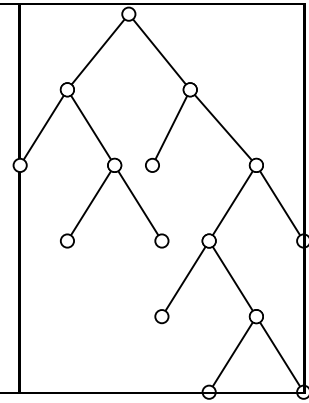

bjoerner-02



bjoerner-03

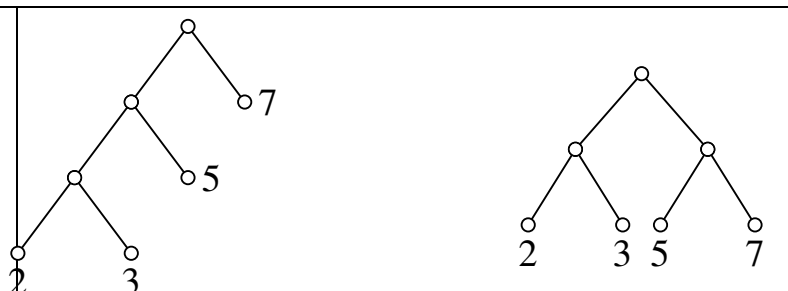

bjoerner-04

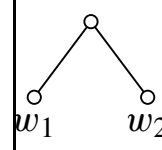

bjoerner-05

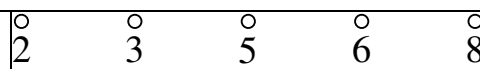

bjoerner-06



bjoerner-07

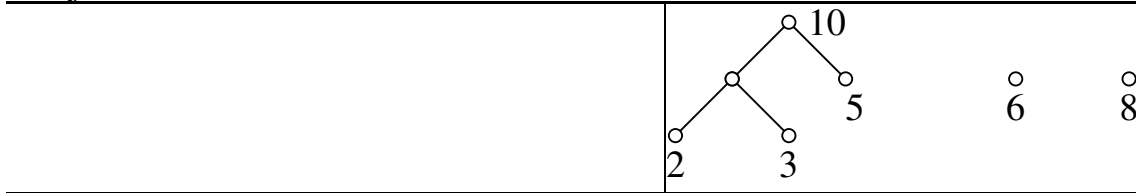

bjoerner-08

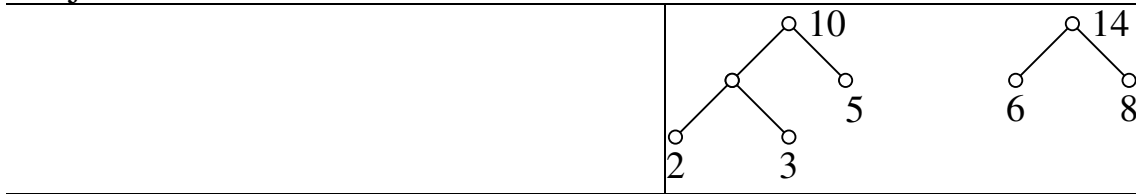

bjoerner-09

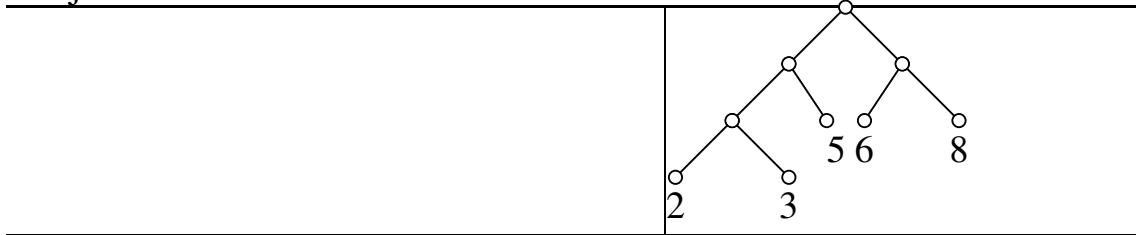

bjoerner-10

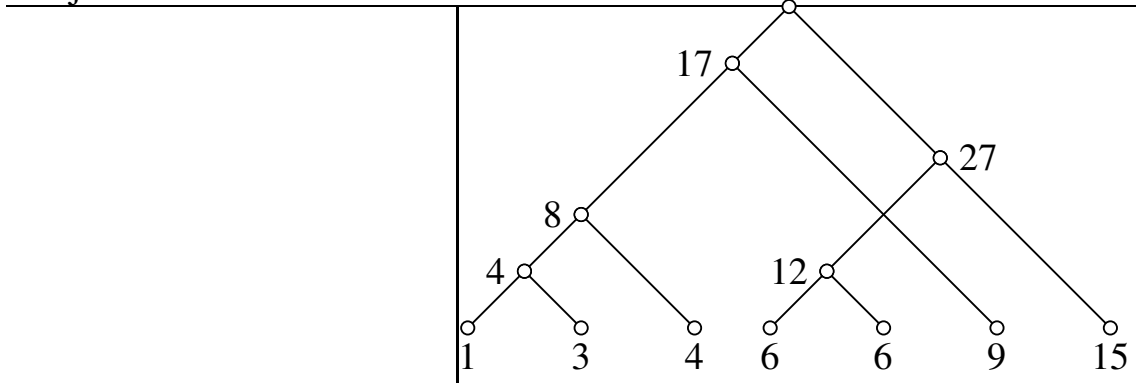

bjoerner-11

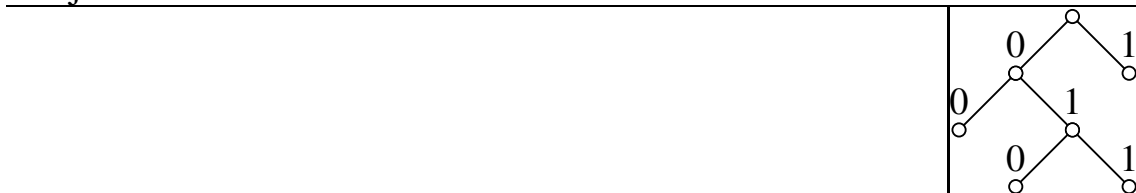

bjoerner-12

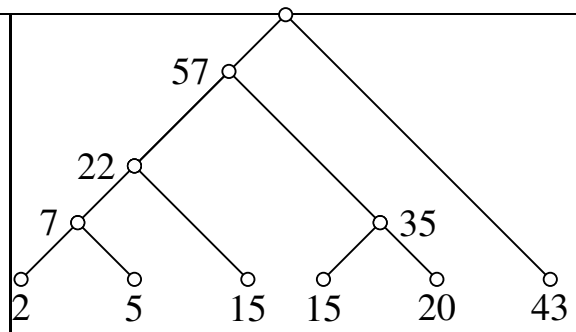

carles1-1

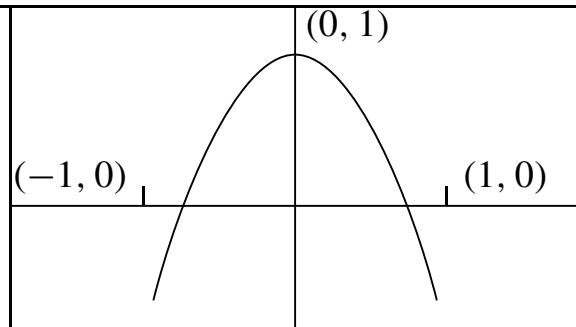

carles1-2

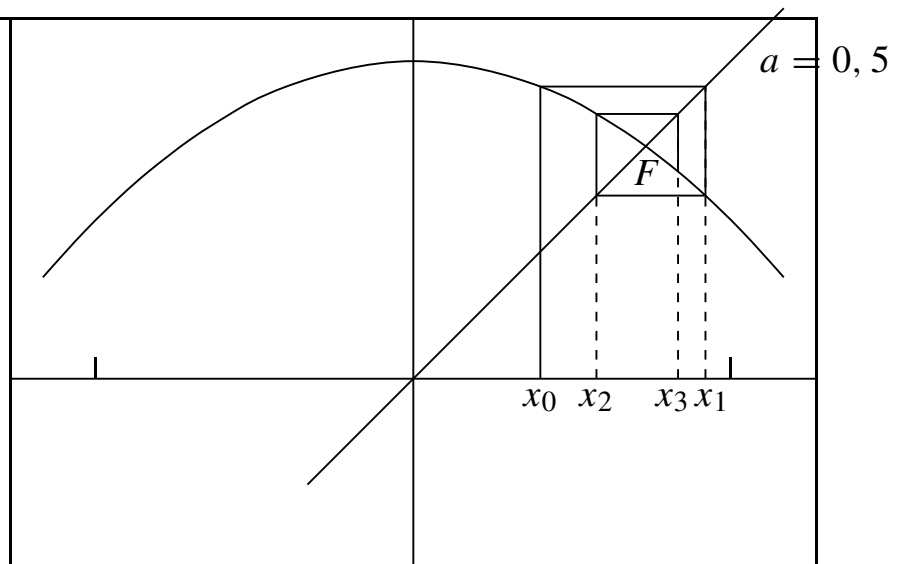

cegrell-1

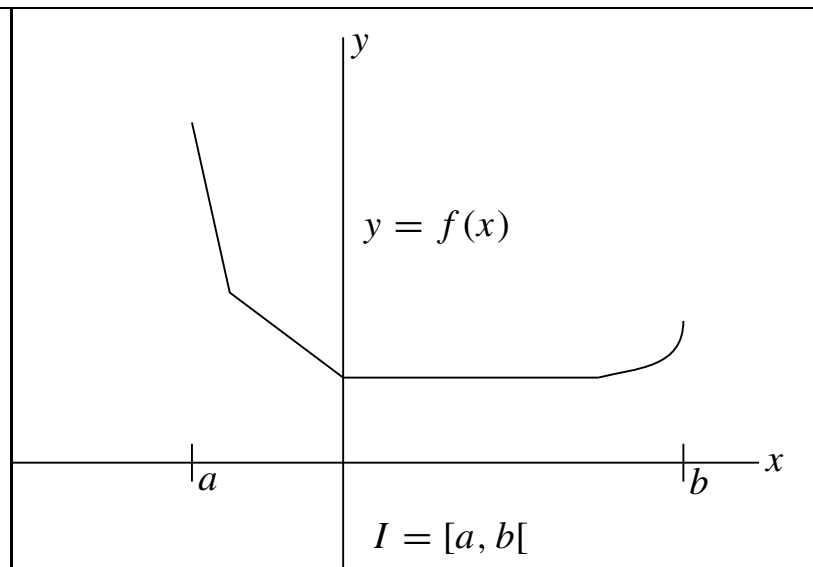

dunkels-1



dunkels-2

PYTHAGORAS' SATS
 $a^2 + b^2 = c^2$

TAXI-PYTHAGORAS' SATS
 $a + b = c$

Fig 2.

dunkels-3

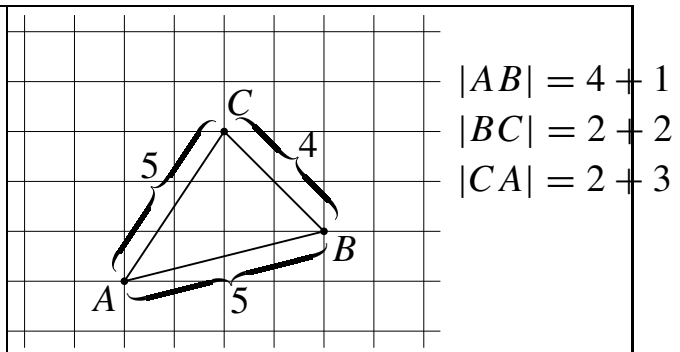
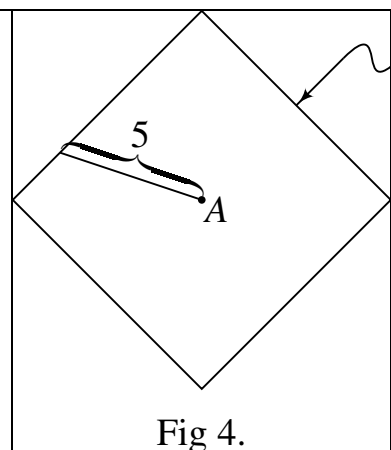

Fig 3.

dunkels-4



Taxi-cirkel

Fig 4.

dunkels-5

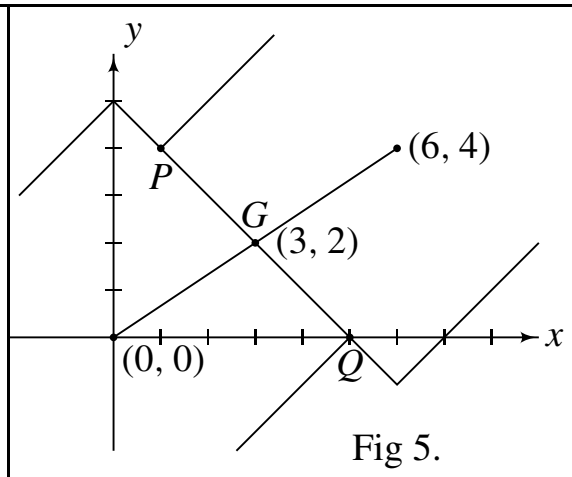

dunkels-6

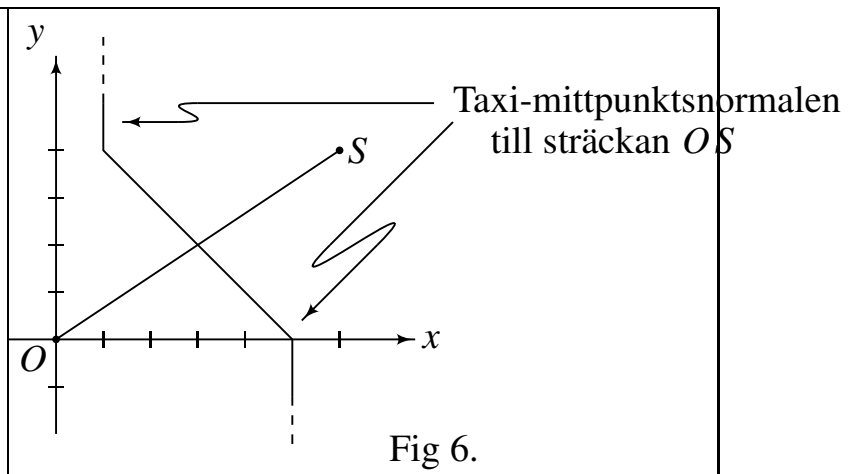

dunkels-7

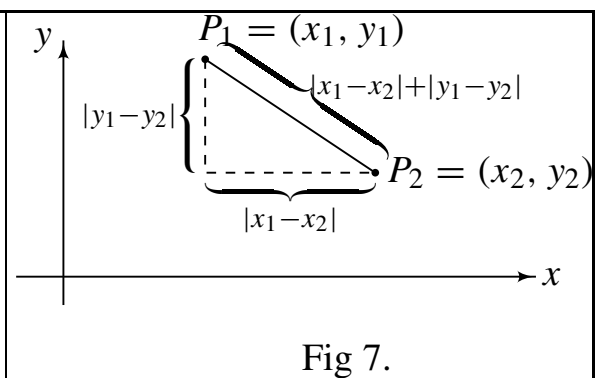

dunkels-8

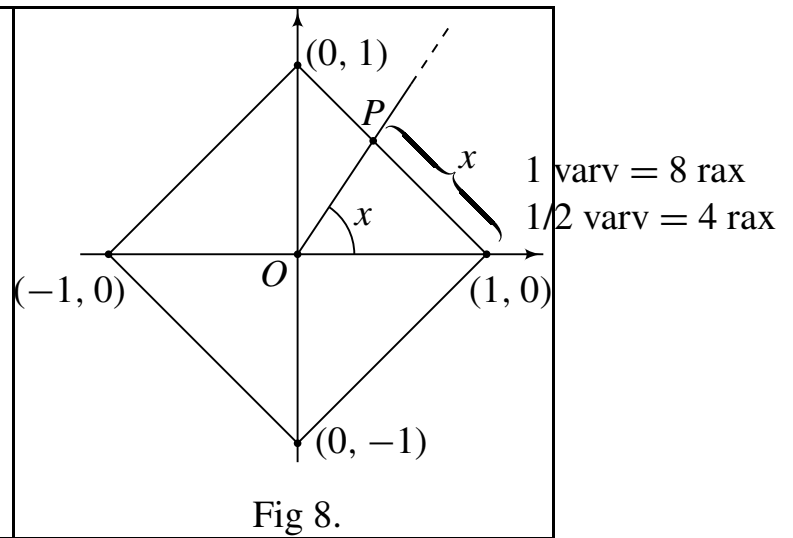

dunkels-9

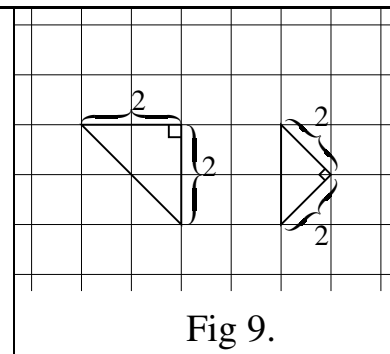

froeberg-1

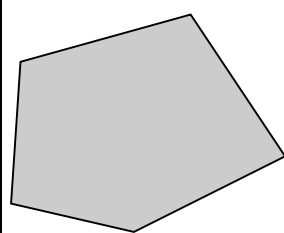

Konveks

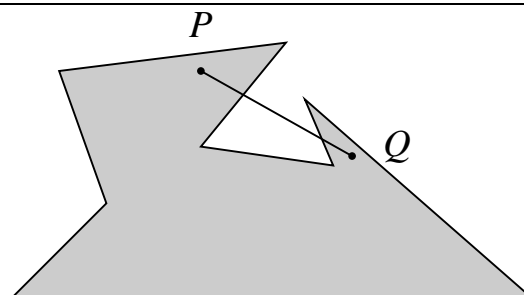

Ej konveks

froeberg-2

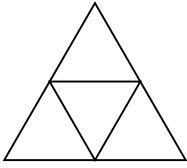
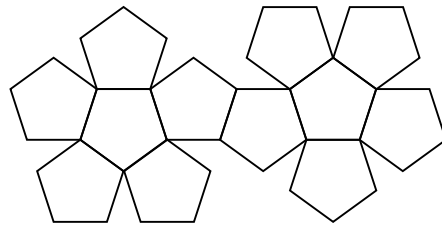
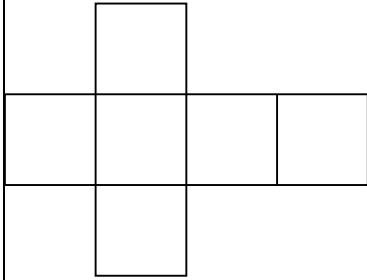
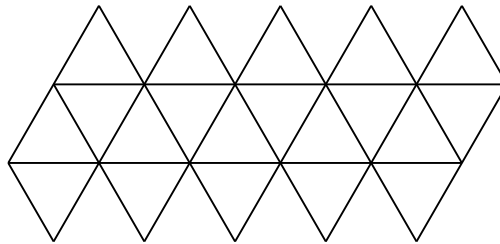
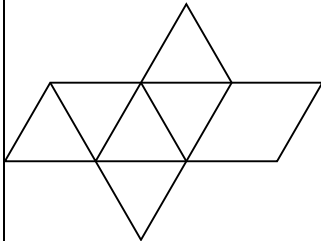
Tetrahedron $\{3, 3\}$ Dodecahedron $\{5, 3\}$ Cube $\{4, 3\}$ Icosahedron $\{3, 5\}$ Octahedron $\{3, 4\}$

hoermand-1

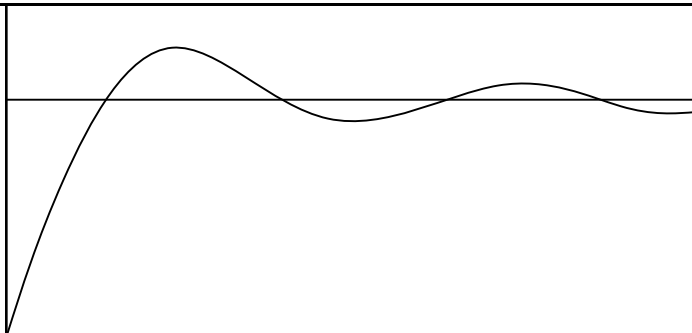

jonsson-1

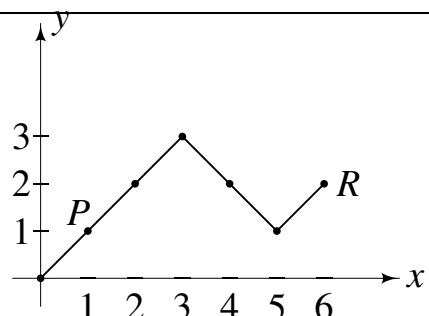
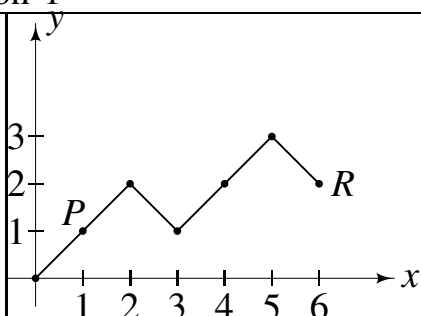

jonsson-2

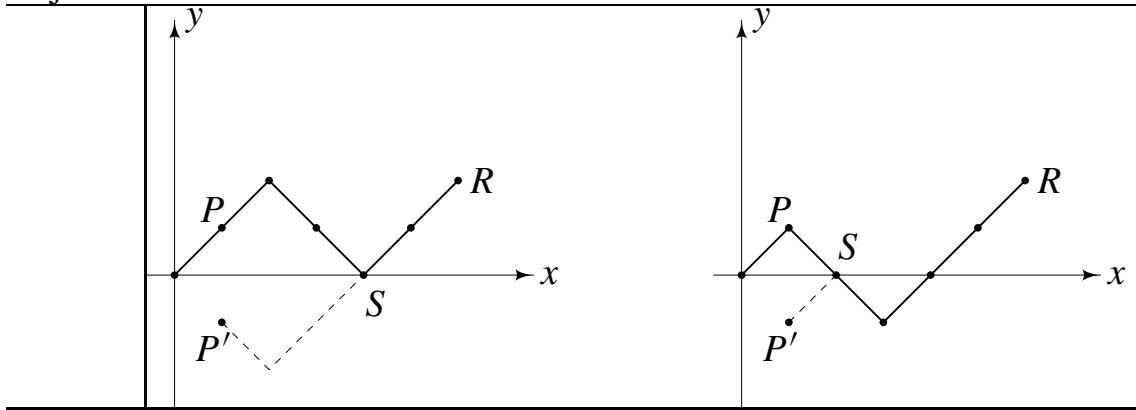

kjell-b-1

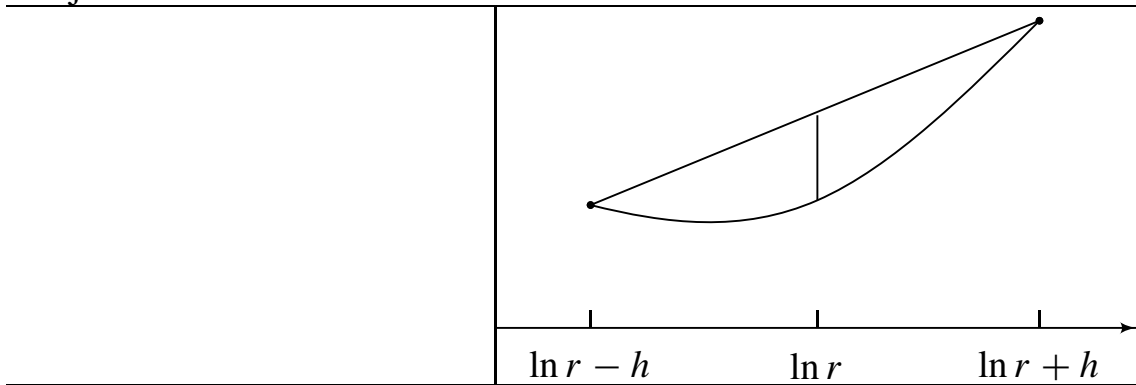

lindstr2-1

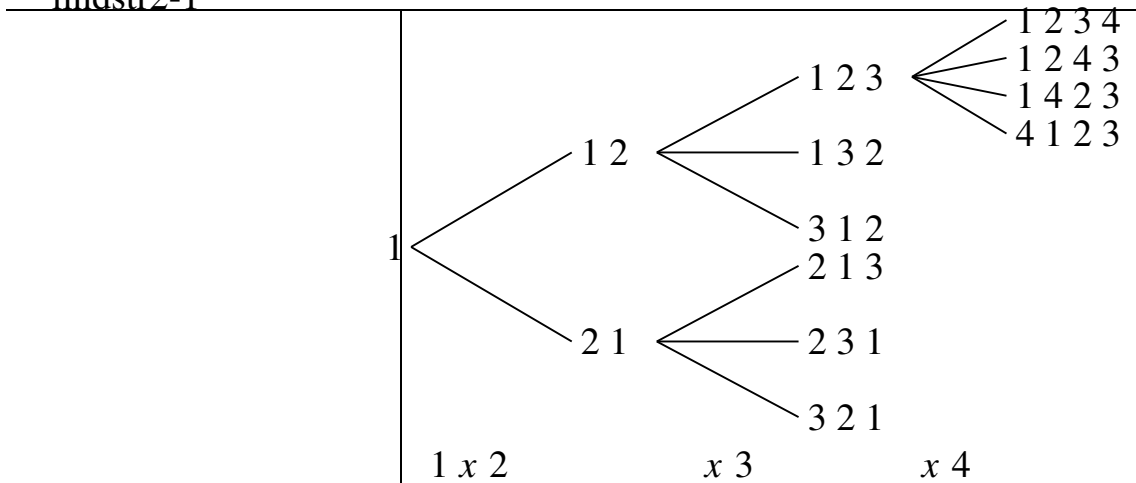

philip-1

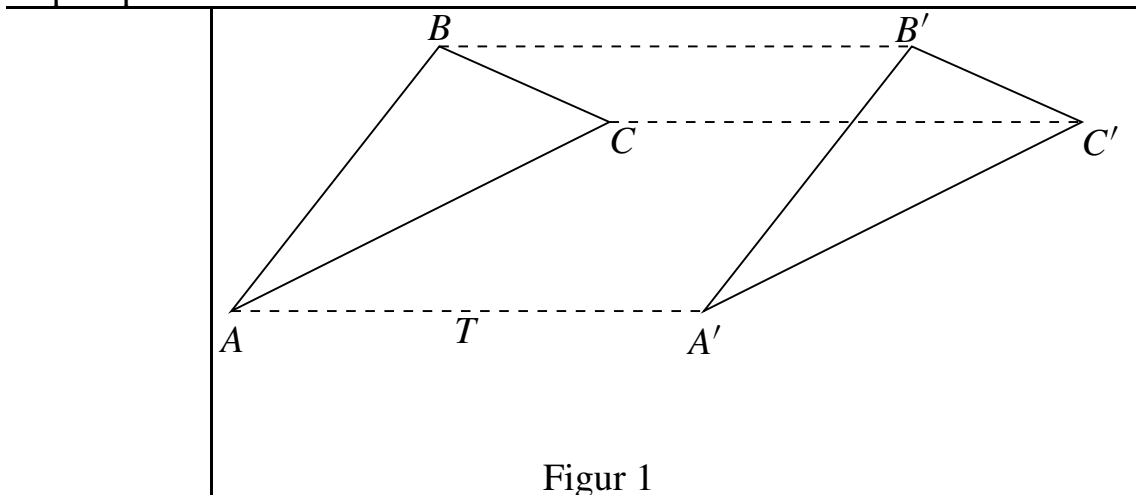

Figur 1

philip-2

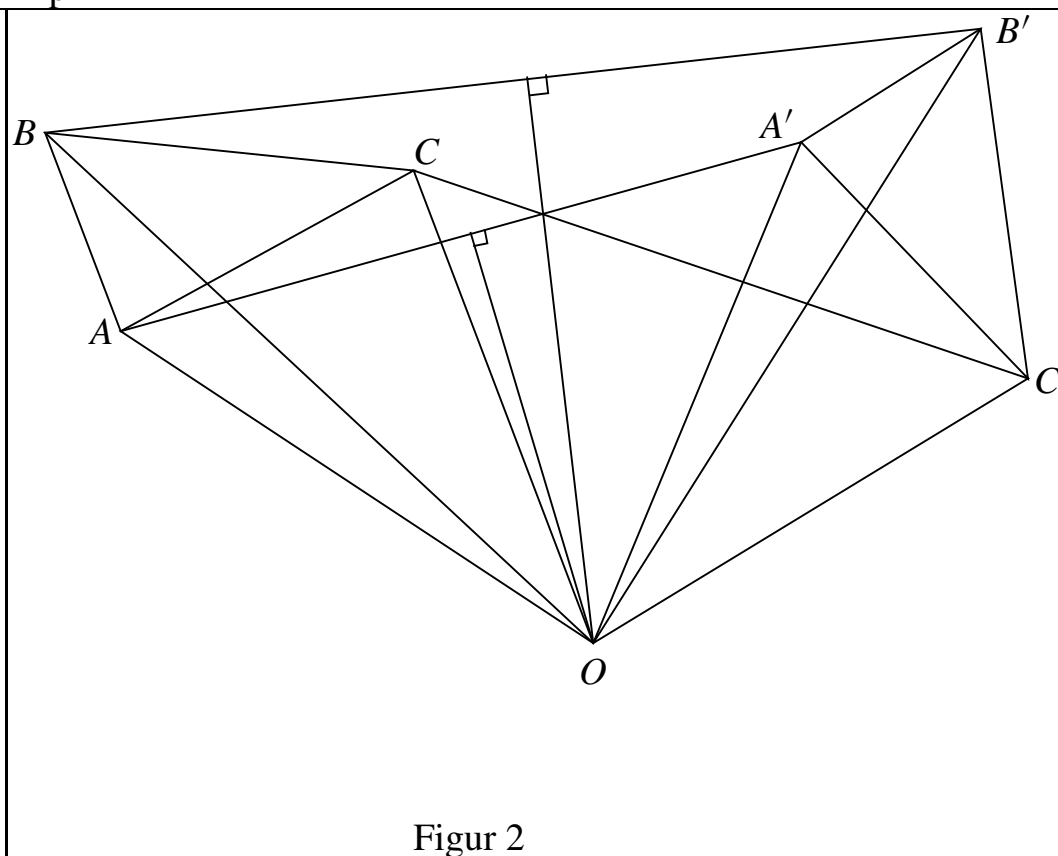

Figur 2

philip-3

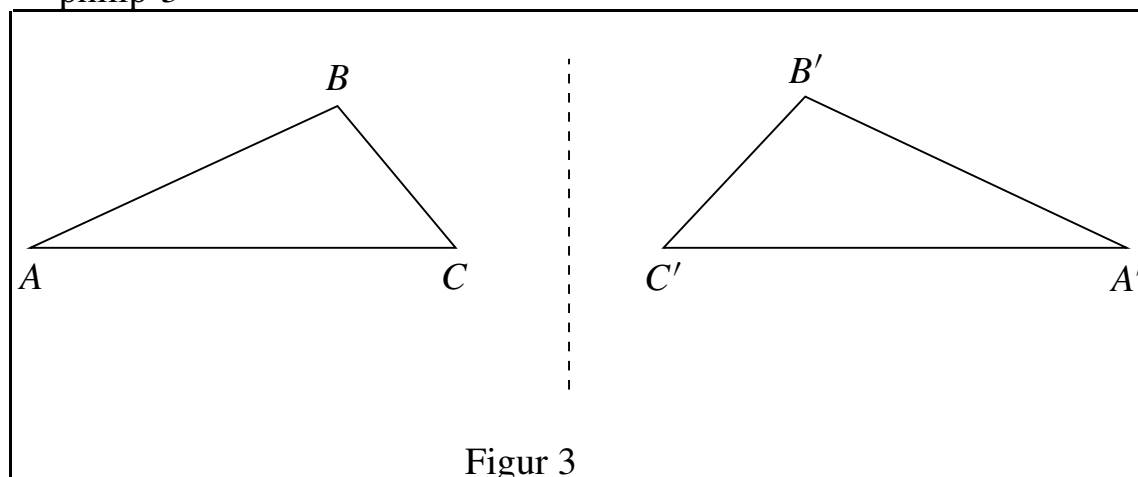

Figur 3

philip-4

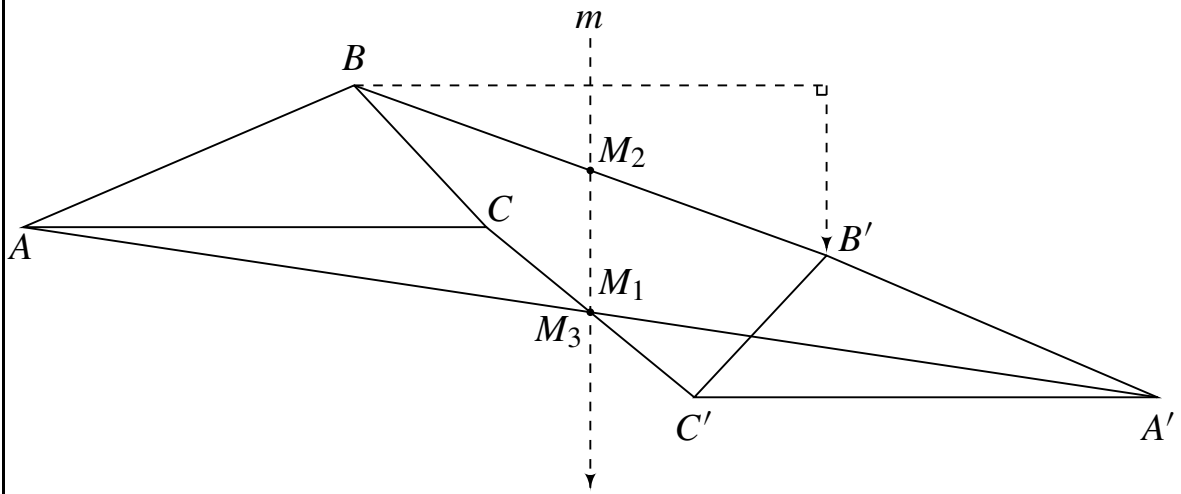

Figur 4

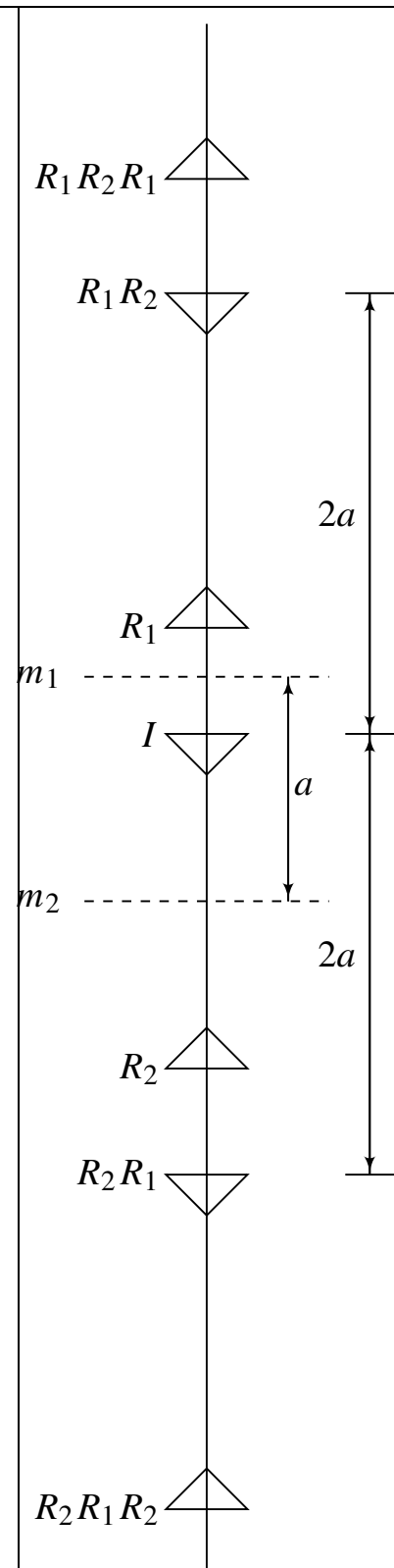

Figur 5

philip-6

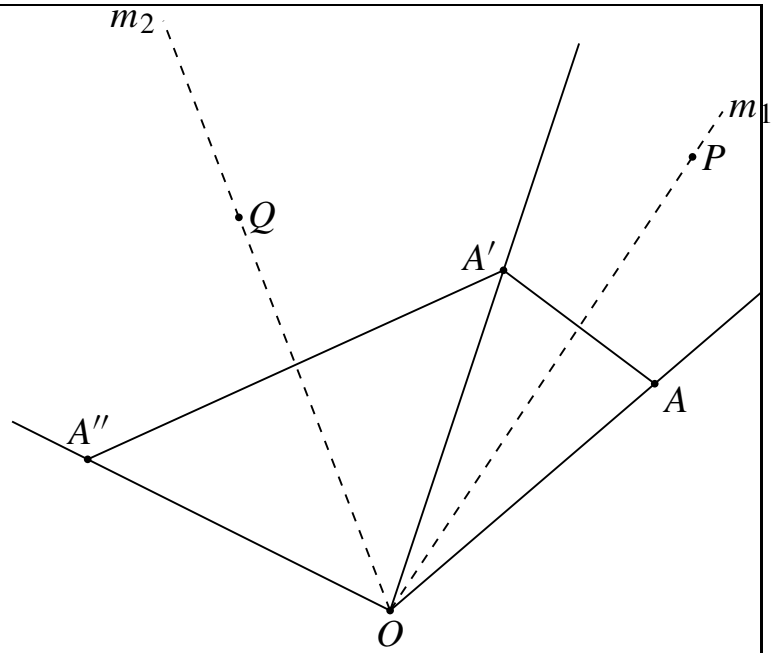

Figur 6

philip-7

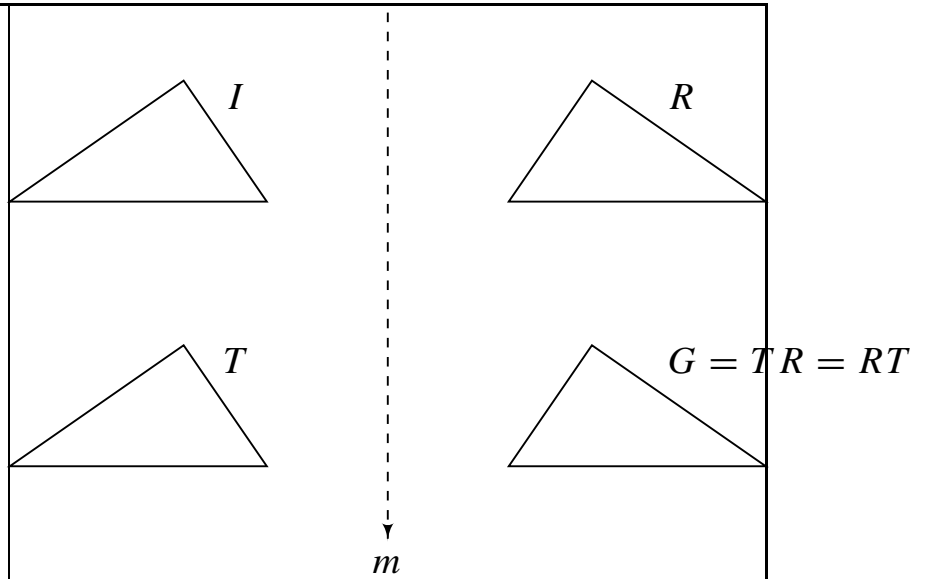

Figur 7

philip-811

 C_1

philip-812

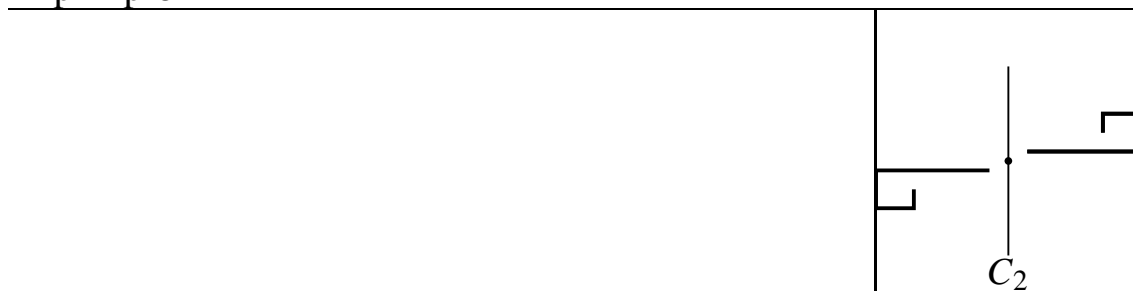

philip-813

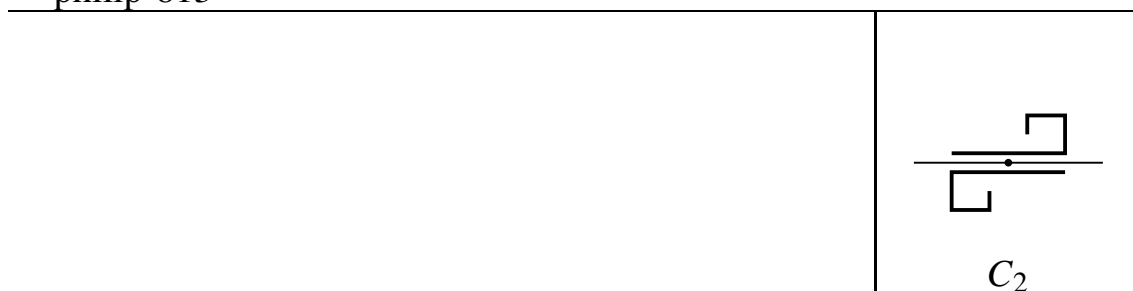

philip-821



philip-822



philip-831



philip-832



philip-833

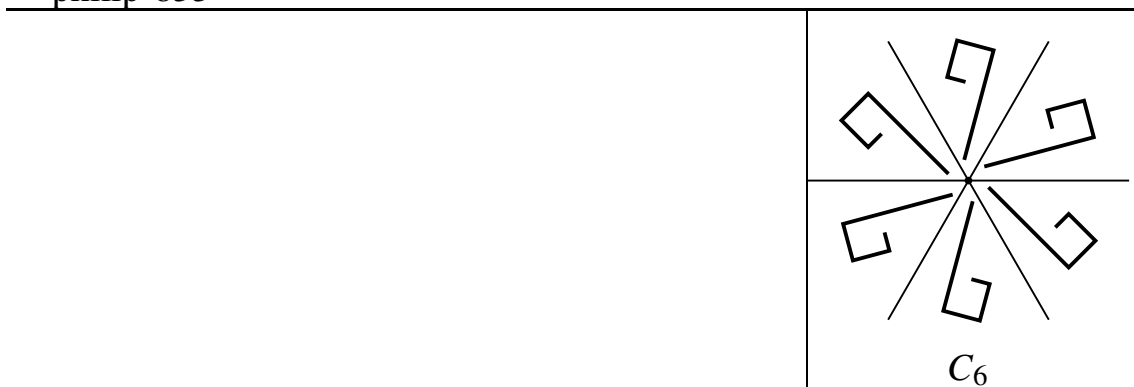

philip-911

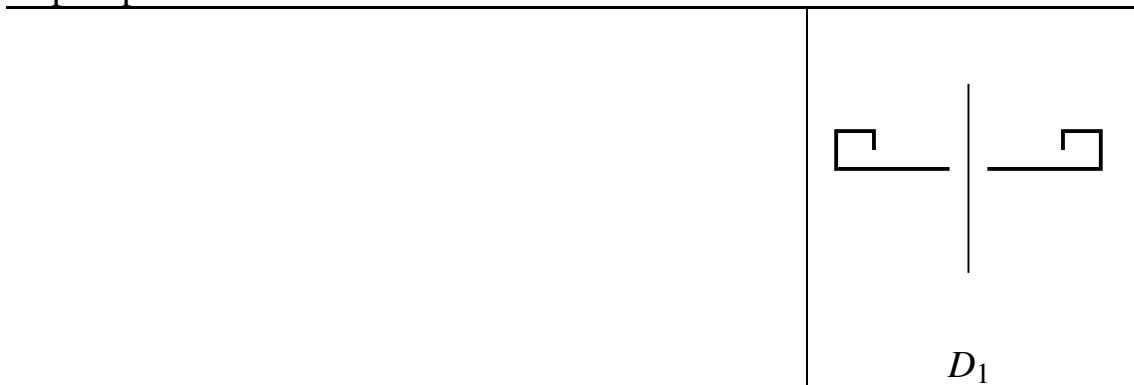

philip-912

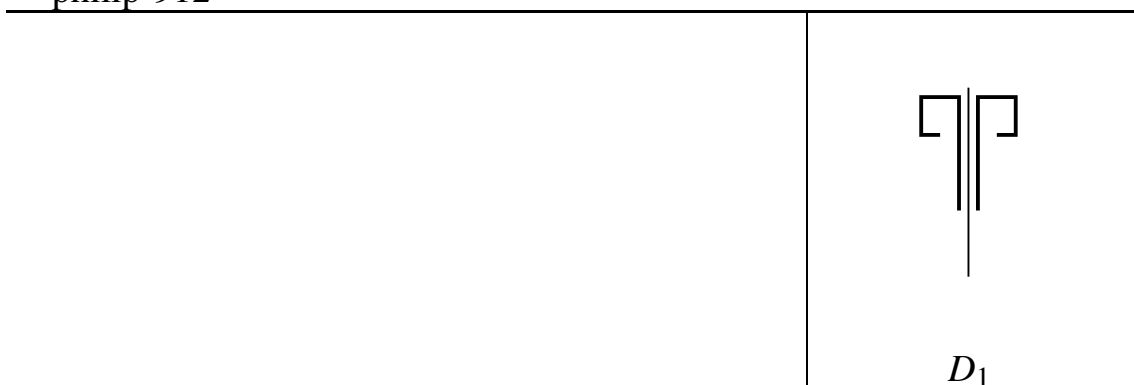

philip-913

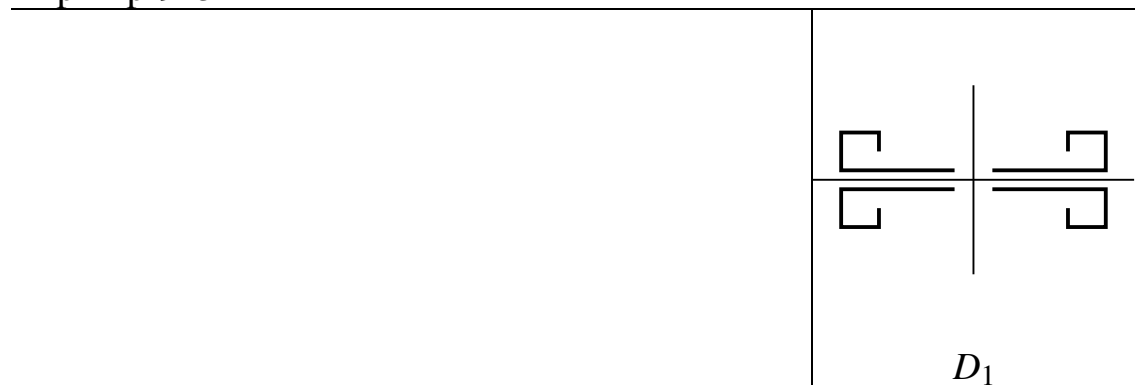

philip-921

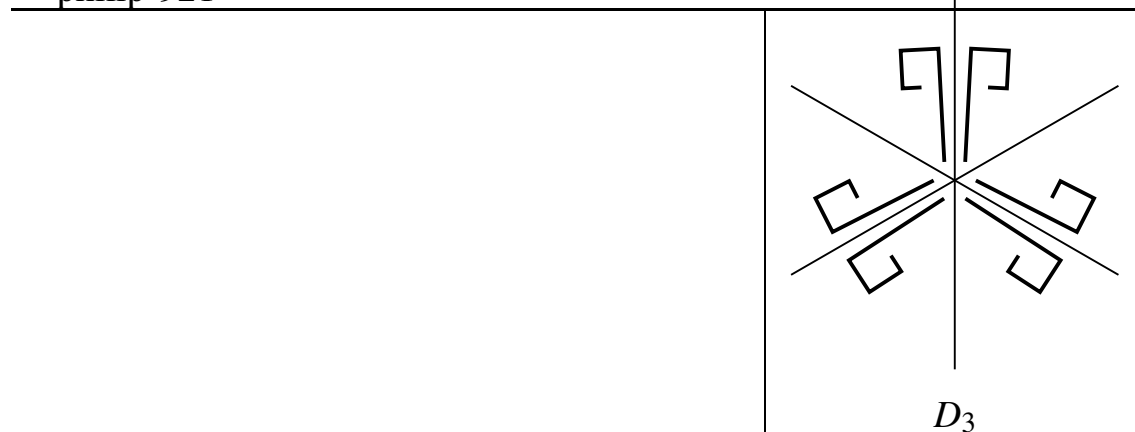

philip-922

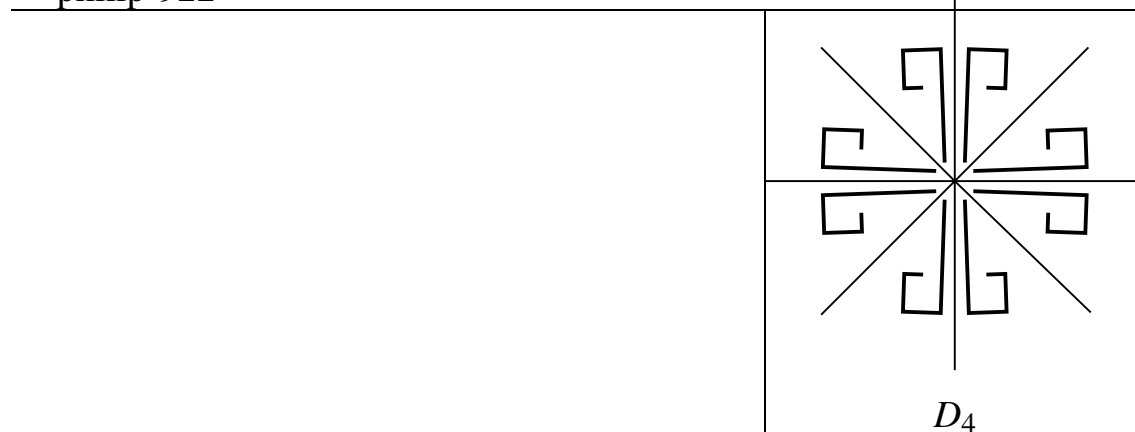

philip-931

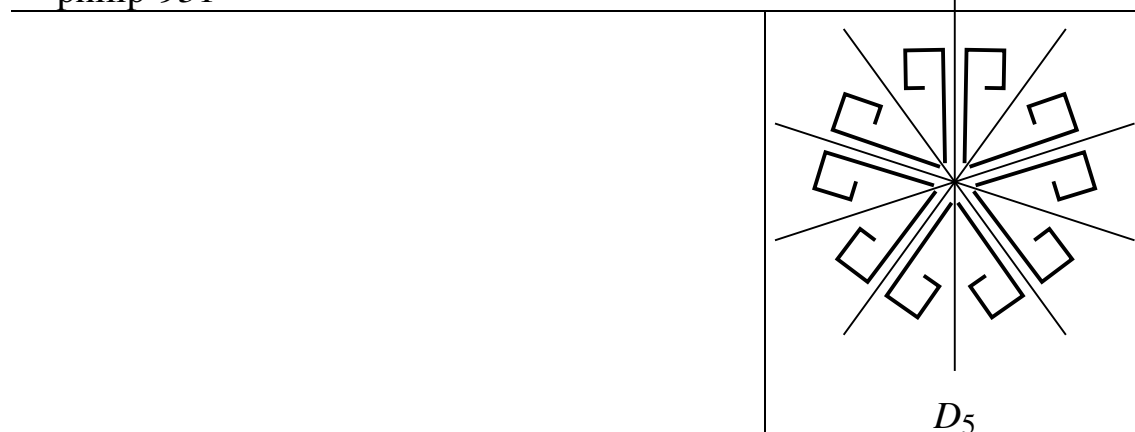

philip-932

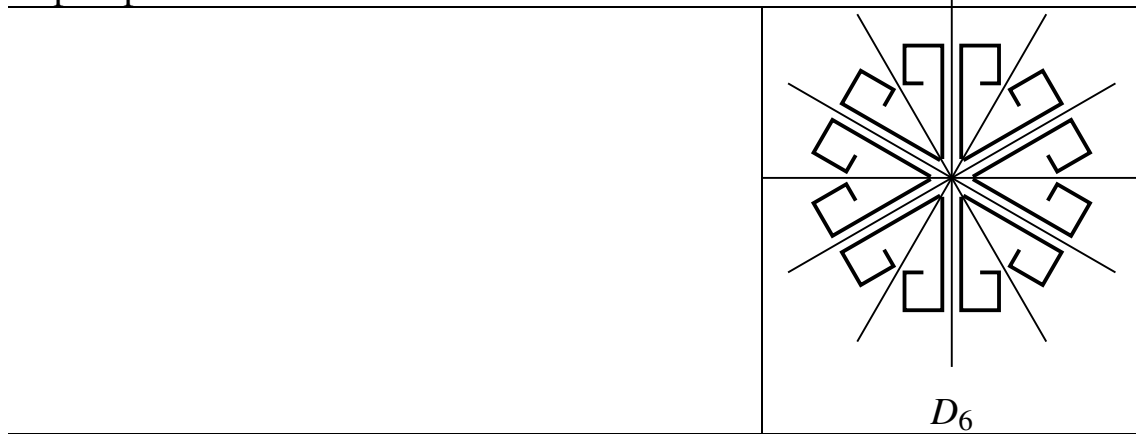

philip-10

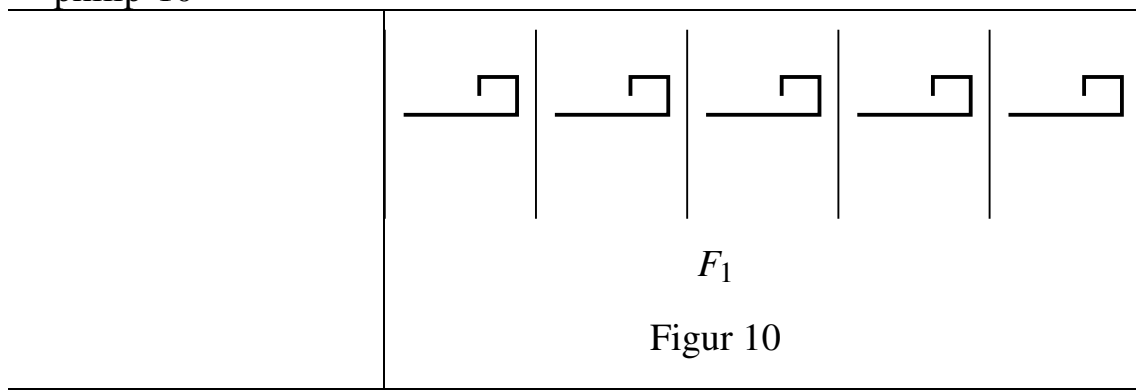

philip-11

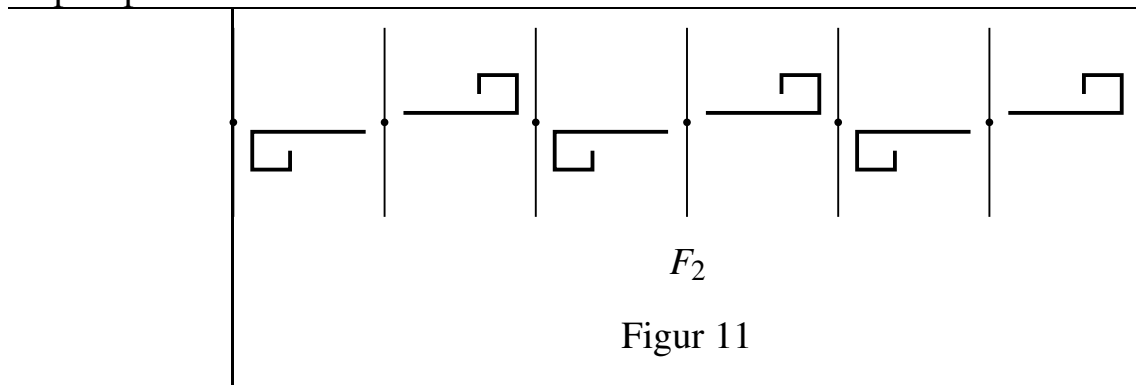

philip-12

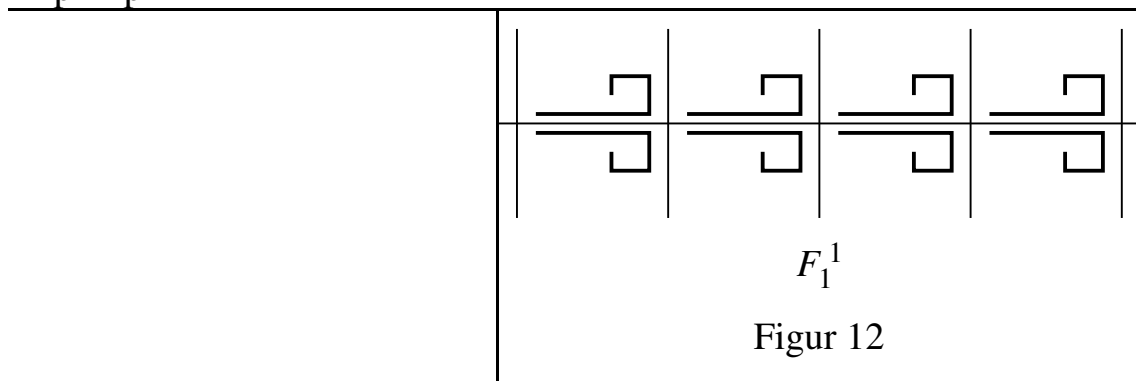

philip-13

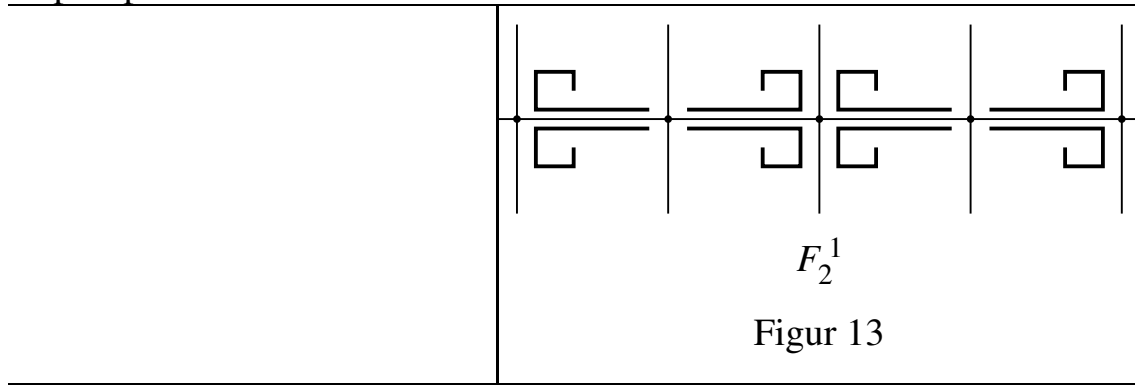

philip-14

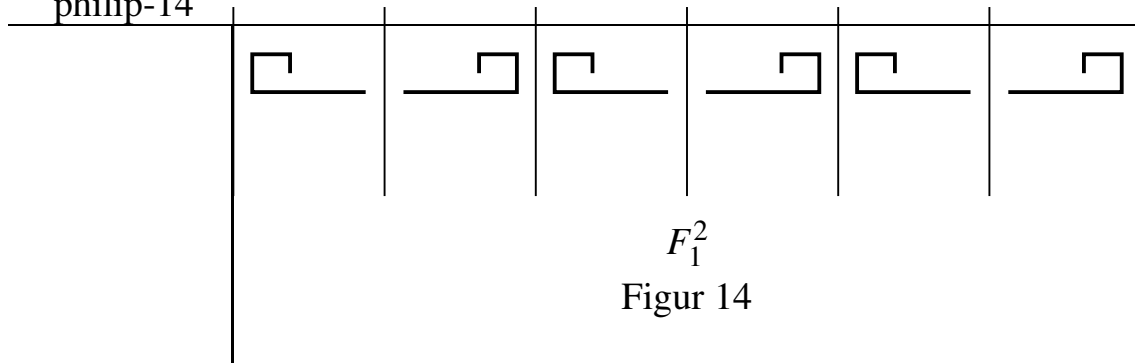

philip-15

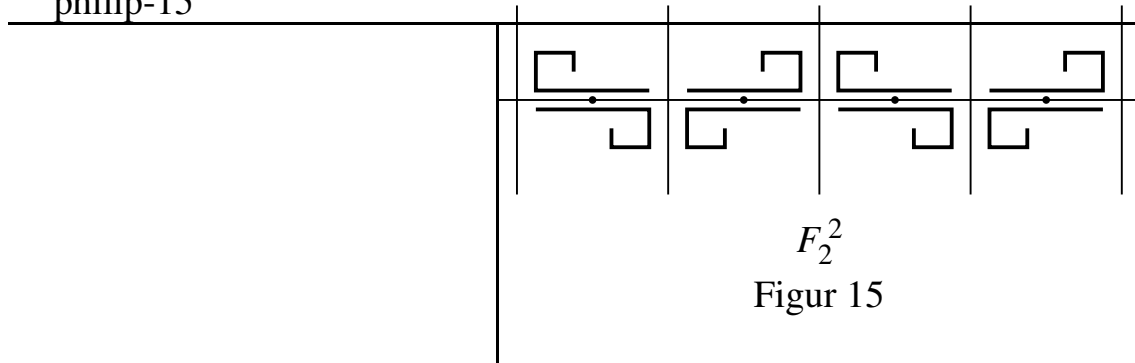

philip-16

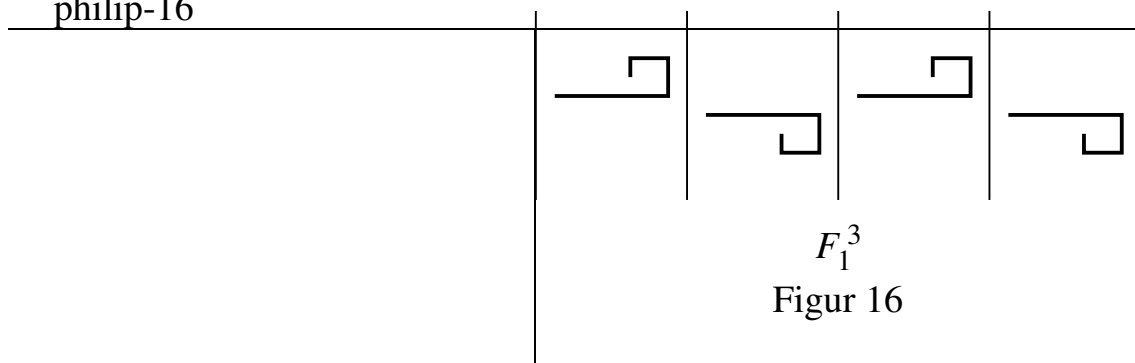

philip-17

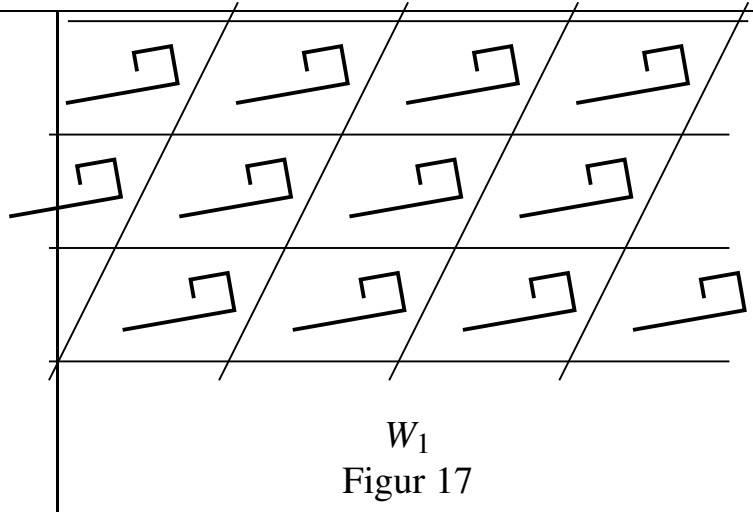

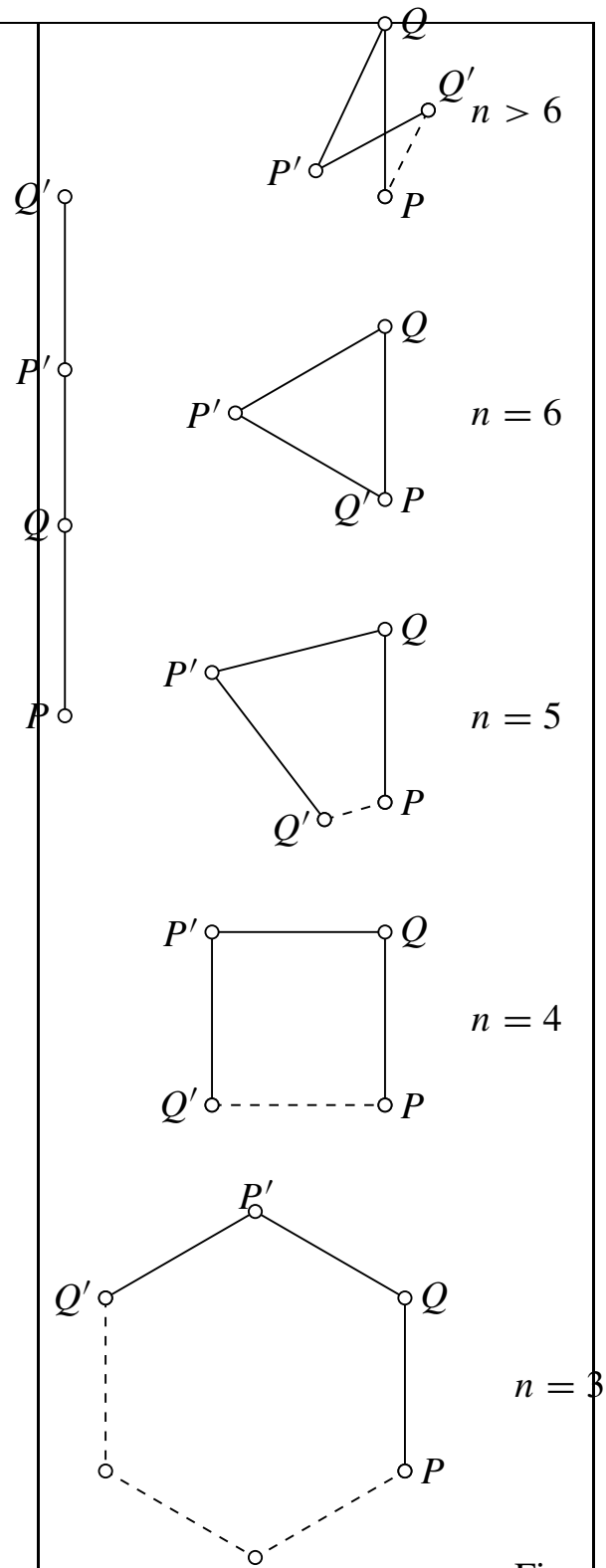

Figur 18

philip-19

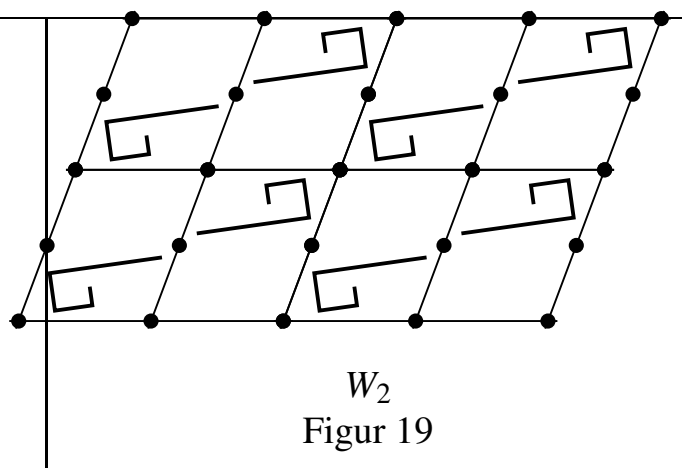

philip-20

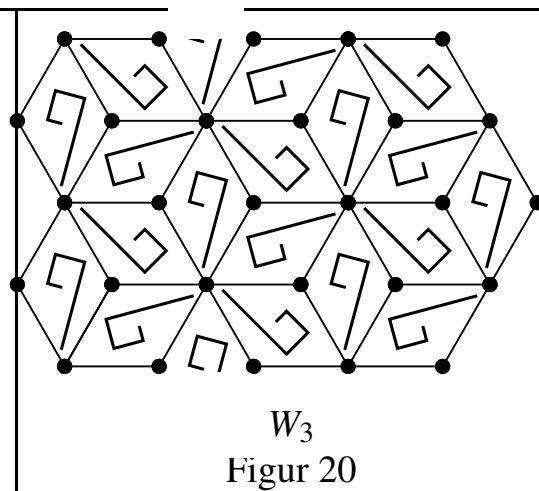

philip-21

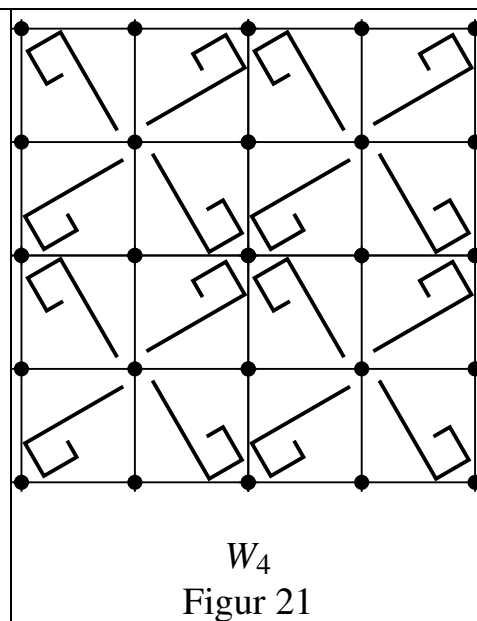

philip-22

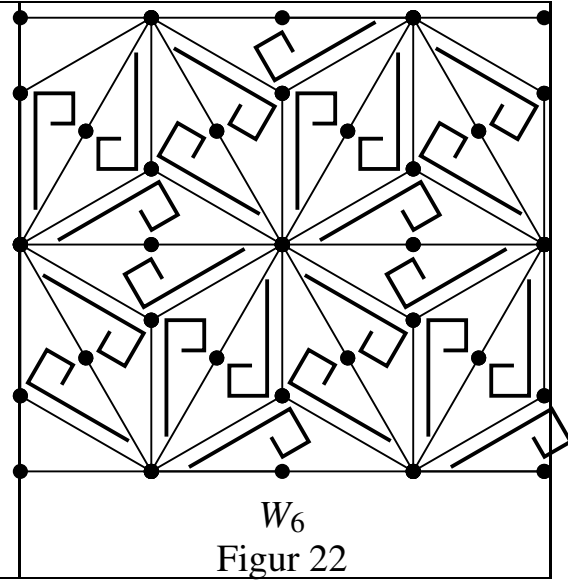

philip-23

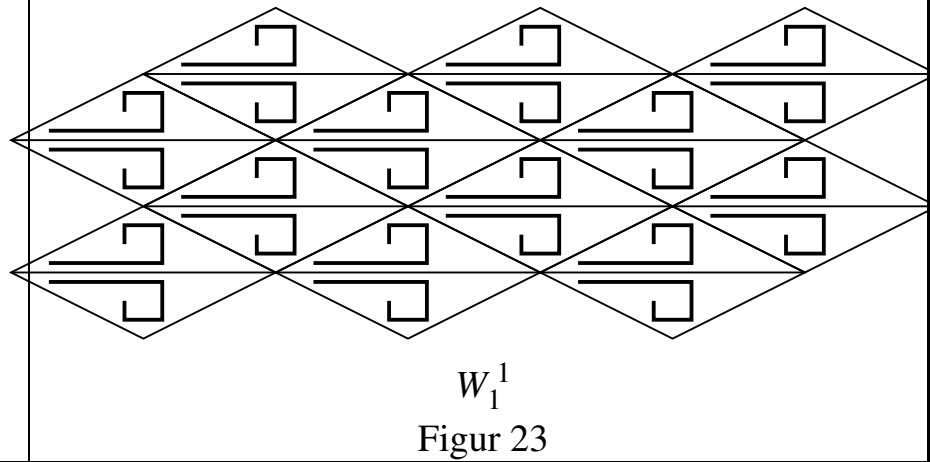

philip-24

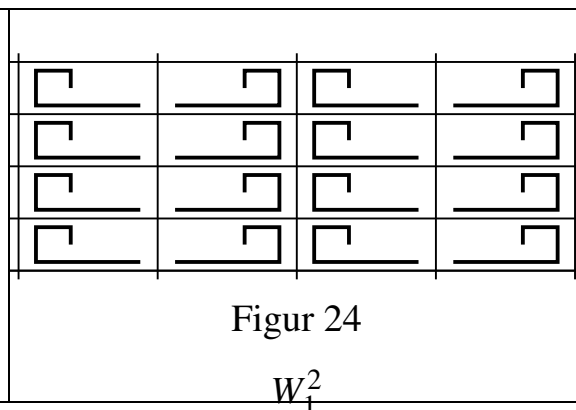

philip-25

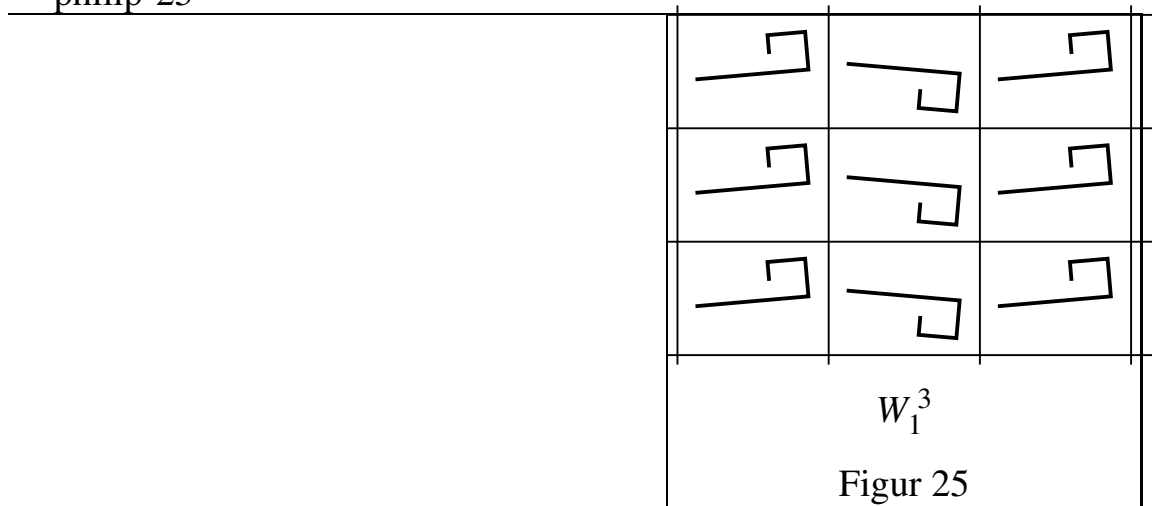

philip-26

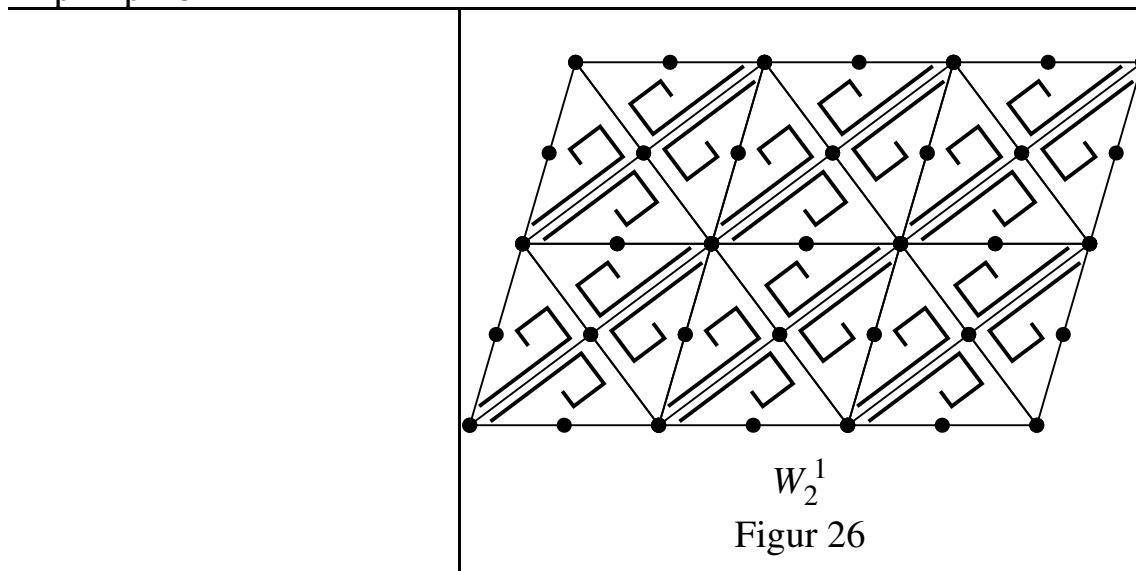

philip-27

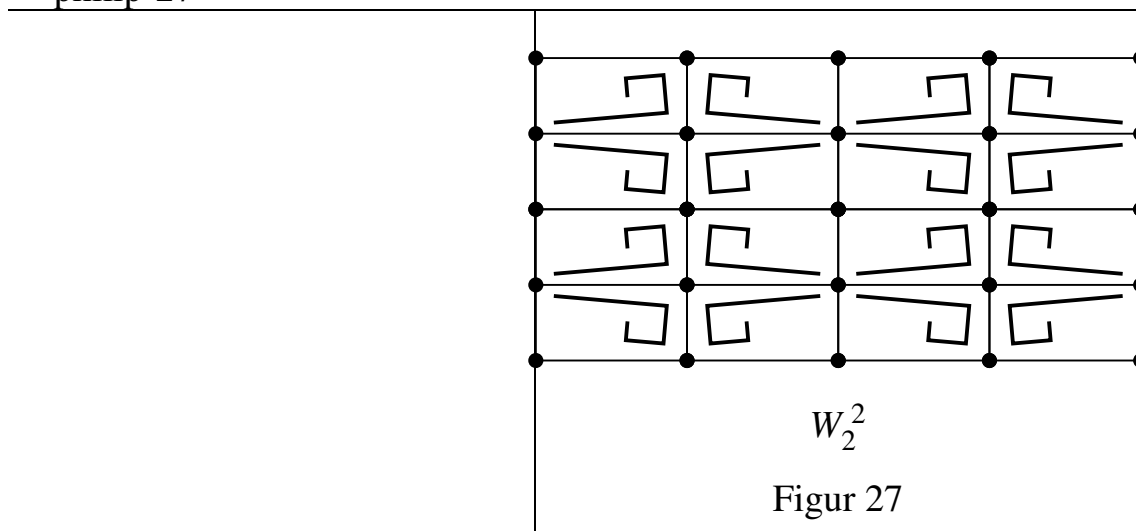

philip-28

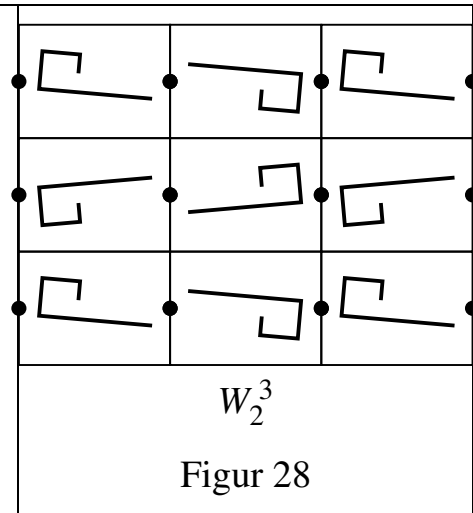

philip-29

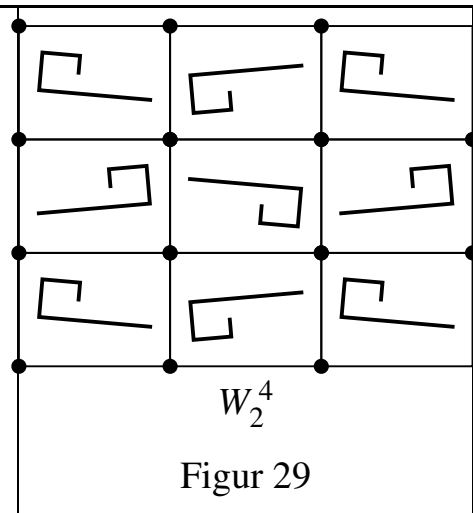

raade-1

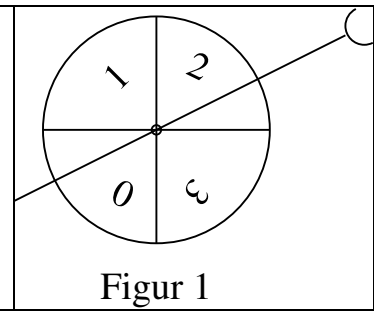

raade-2

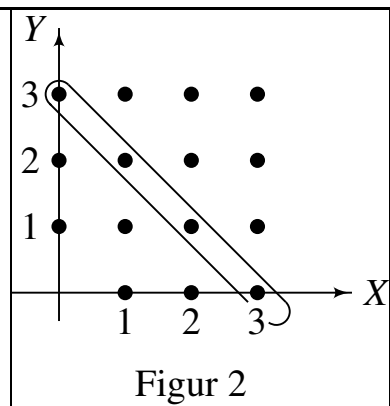

raade-3

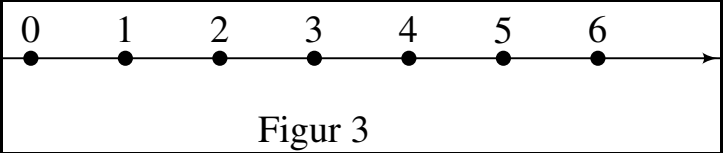

Figur 3

raade-4

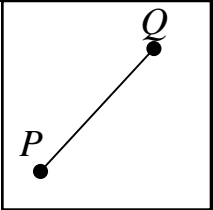

Figur 4

raade-5

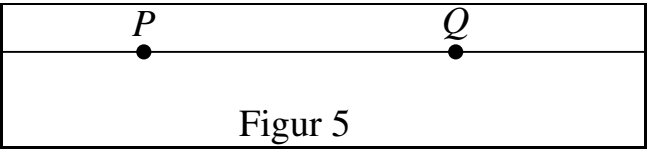

Figur 5

raade-6

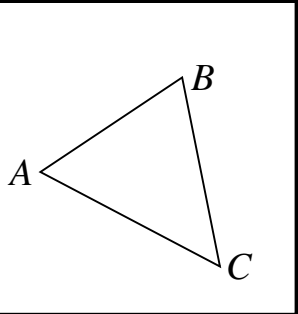

1

Figur 6

roedseth-1

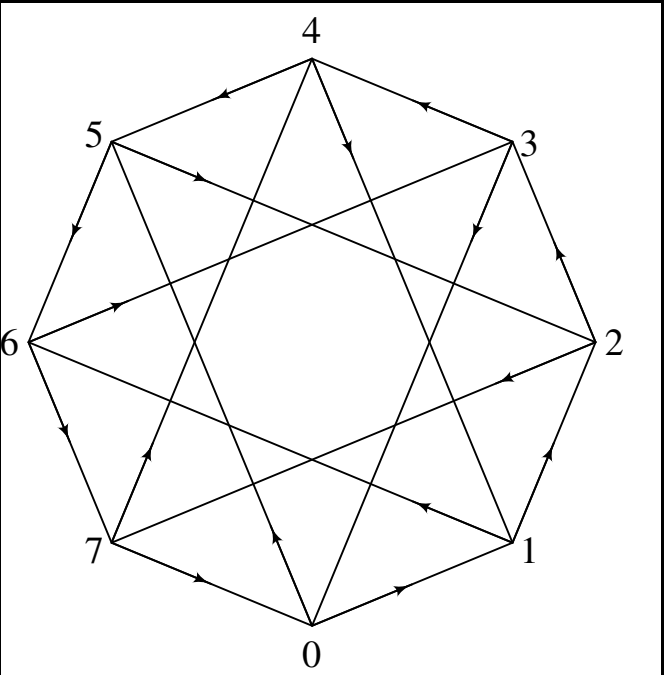

Figur 1

roedseth-2

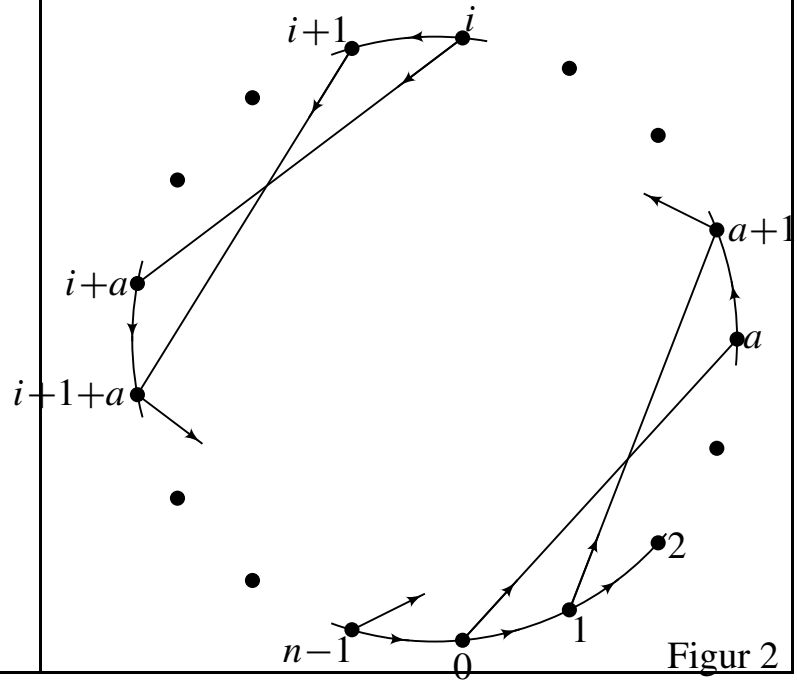

Figur 2

roedseth-3

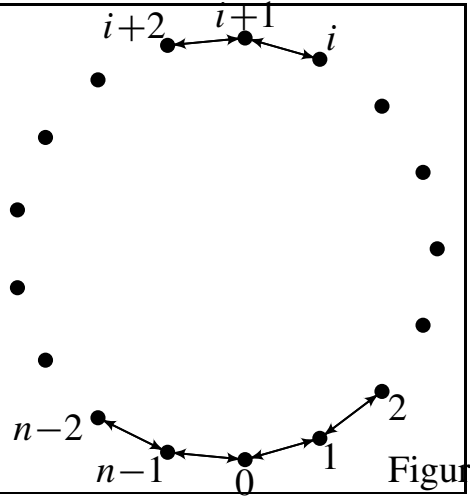

Figur 3

sjoegren-1

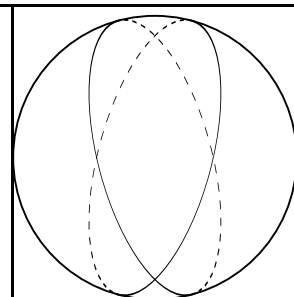

Figur 1

sjoegren-2

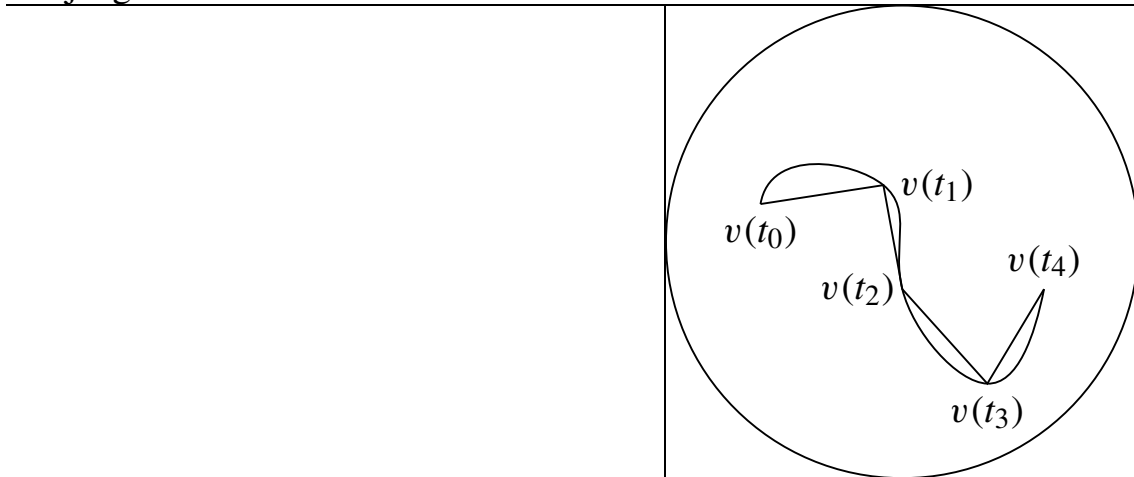

Figur 2

sjoegren-3

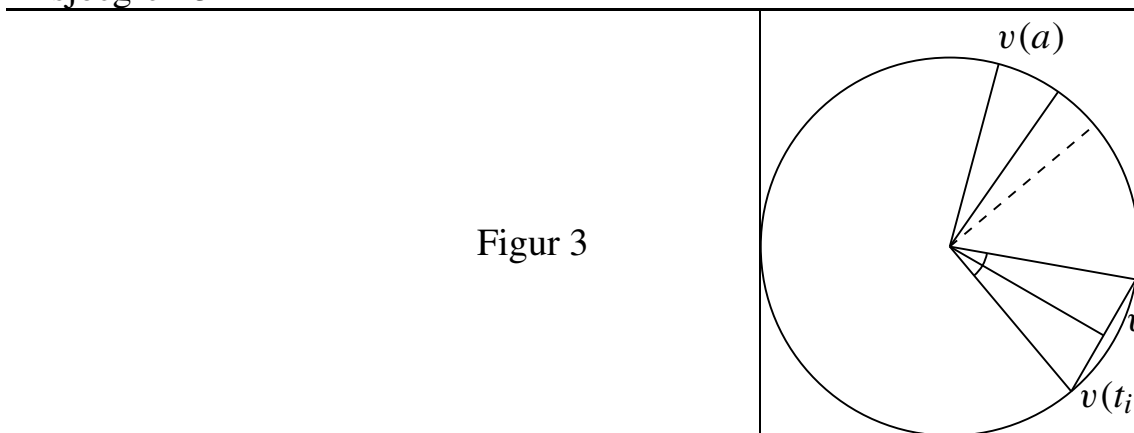

Figur 3

svensson-1

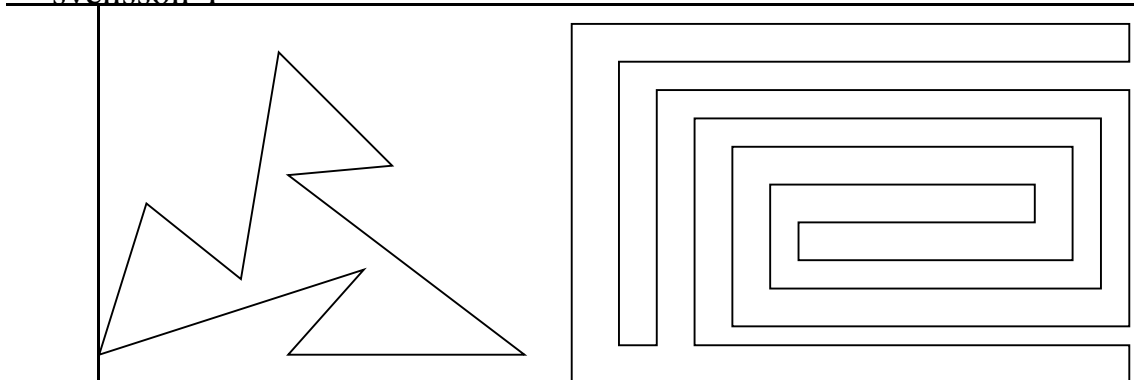

svensson-2

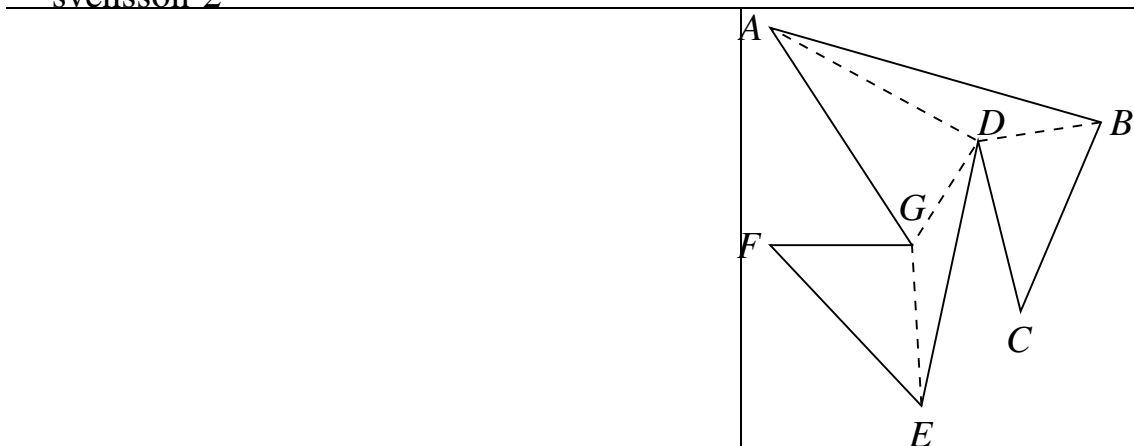

svensson-3

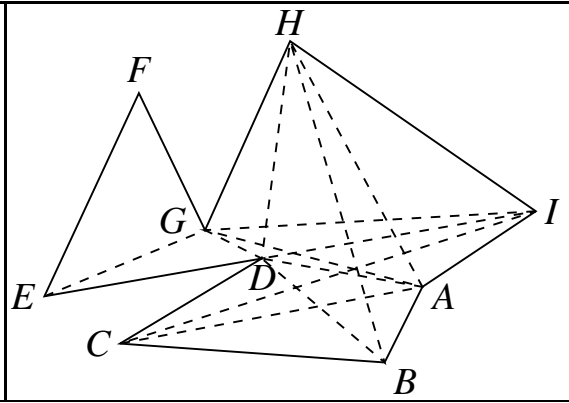

svensson-4

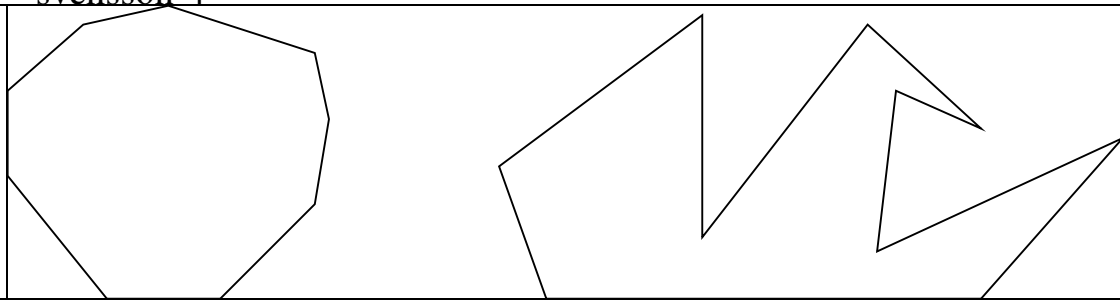

wallin-1



wallin-2

